

# "Tropical Daydream"

designed by Teresa Wentzler, TW Designworks

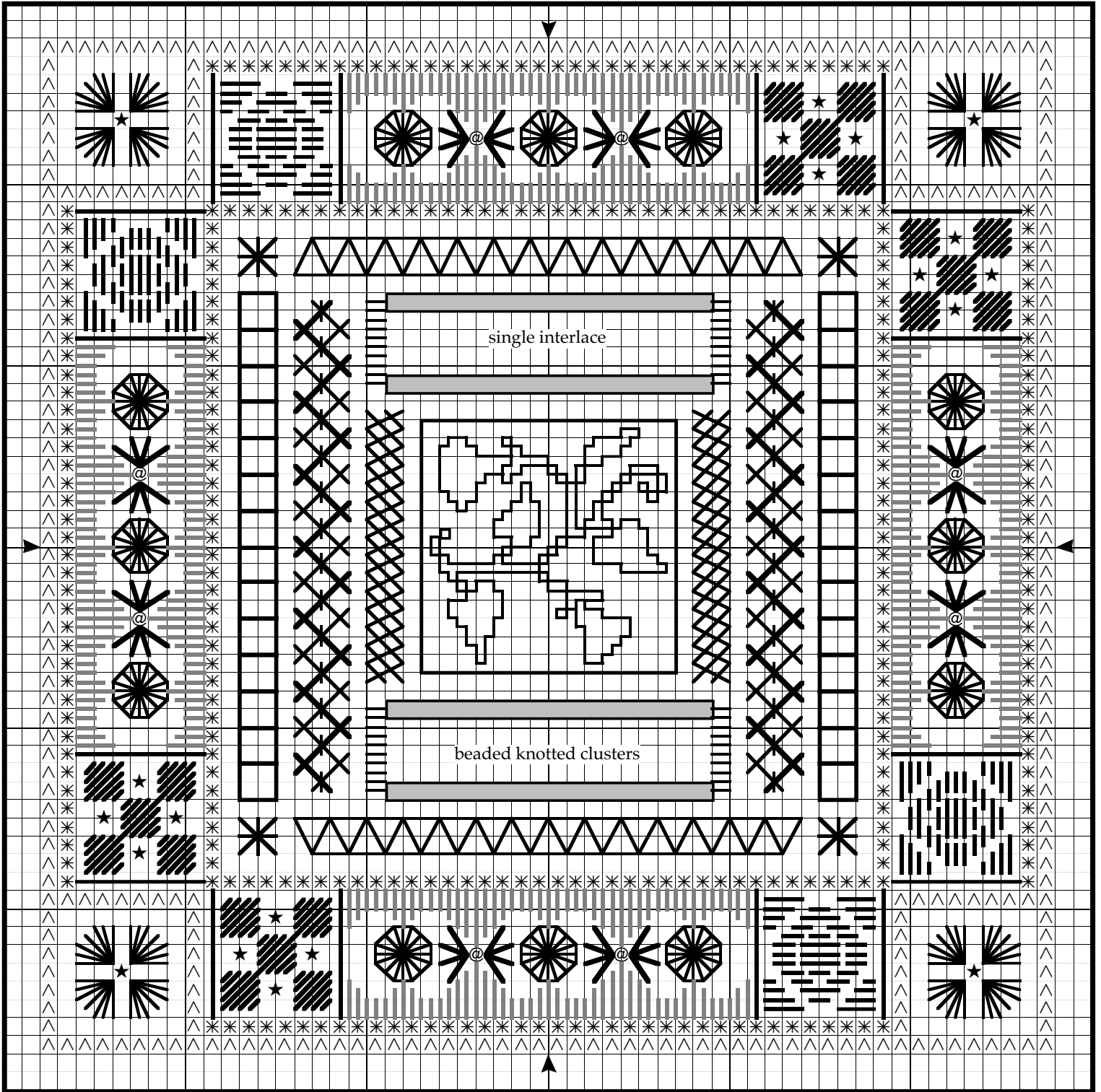

Stitch this piece as an introduction to "Tropical Dream".

Completion of this design will prepare you for nearly all of the specialty stitches and techniques you'll find in that piece, and will give you some experience working with the metallics, overdye fibers and beads required as well.

ENJOY!

©2004, Teresa Wentzler, TW Designworks, PO Box 176, Montoursville, PA 17754. All rights reserved.  
Online: [www.twdesignworks.com](http://www.twdesignworks.com)

## "Tropical Daydream"

(teaching piece for "Tropical Dream")

designed by Teresa Wentzler  
for

*The Bermuda Guild of Stitchery*  
*Spring Workshop: April 2 - 3, 2004*

	DMC	Anchor	color name
■	161	122	gray blue
W	160	121	gray blue, med.
◆	[ 161 3041	[ 122 872	[ gray blue antique violet, med.
⊗	[ 160 3042	[ 121 870	[ gray blue, med. antique violet, lt.
□	[ 159 3743	[ 117 869	[ gray blue, lt. antique violet, v. lt.
Y	676	891	old gold, lt.
●	3362	861	pine green, dk.
✕	3363	860	pine green, med.
⊕	523	858	fern green, lt.
^	[ 676 437	[ 891 362	[ old gold, lt. tan, lt.
no symbol	blanc	02	white
no symbol	760	122	salmon
no symbol	3727	1016	mauve, lt.

### Mill Hill Glass Beads:

@	03051	misty (antique)
★	00479	white (seed)

### Dinky-Dyes Overdyed Cotton:

✱	22	sapphire
---	----	----------

### Kreinik Metallics:

no symbol	3200	ombre	pearl
-----------	------	-------	-------

(see instructions)

### DMC Pearl Cotton:

no symbol	blanc	#5	snow white
no symbol	blanc	#8	white
no symbol	blanc	#12	white

(see instructions)

### Caron Collection Watercolour:

no symbol	133	delphinium
-----------	-----	------------

(see instructions)

## Design Information:

Model stitched over-two on 20-count

Bone Lugana from Zweigart®

Stitch count: 56H X 56W

Finished design size: @ 5-3/4" X 5-3/4"

**\*\*This design is not suitable for aida.\*\***

## General Instructions:

### PLEASE READ ALL INSTRUCTIONS BEFORE BEGINNING TO STITCH.

Cross stitch over-two using four strands floss. (Dinky-Dye Cotton: use three strands for cross stitch.) When two floss colors are bracketed together, use an equal number of strands of each color together in your needle. Always use one strand of the Watercolour fiber, the Ombre, and all perle cottons. Backstitch using two strands of floss, unless indicated otherwise. Stitch over-one areas using two strands of floss. Attach all beads using one strand white floss after all other stitching has been completed.

### Using Overdyed fibers:

The charm of overdyed fibers is the wonderfully smooth "flow" of one color into another. In order to preserve those transitions when stitching with overdyeds, you'll need to complete each cross stitch before you move on to the next one. When you need to start your next length of fiber, thread your needle so that the color you ended with is the color you now start with...this will help preserve the illusion of unbroken color transitions in your stitching.

### For the best results, please stitch the steps in the order given.

1. Complete all cross stitch first, including (✱).

### Border:

2. Stitch the **Pattern Darning** blocks:  
a. Using #8 cotton, stitch the backstitch lines at the edges if the pattern darning blocks. These stitches serve as "anchors", and are necessary for correct execution of the darning. These rows make it possible to "turn the corner" and come back the next row while keeping the ends of the rows tidy. You are, in essence, weaving within the existing fabric threads, and those anchoring rows act as the selvege edges.

b. Take a moment to look at the darning pattern. It's simply a series of rows of running stitches of varying lengths.

c. Thread a needle with #5 cotton. On the backside of your work, anchor the thread at the lower right edge of the section. Come up through the fabric where the pattern starts, and stitch to the left, across the entire row.

d. When you get to the end of the row, go down through the fabric, and on the backside of your work, catch an anchoring thread (remember those vertical row of backstitches?), turn, come up through the fabric, and start back across the next row, following the pattern.

e. When you get to the end of that row, repeat the procedure: catch the anchoring stitch on the back, and bring your needle up through the fabric and begin the next row. **Please Note: There is a gap of one fabric thread between the vertical rows of backstitching and the darning pattern.**

**HISTORICAL NOTE:** Many years ago, pattern darning was used as an exercise to teach young girls "darning" or "mending". It can be very simple, as in this design. Or it can be quite complex, as in the rich patterns of opulent, luxurious damasks.... it's all pattern darning!

3. Complete **Diagonal Satin Stitch** block areas using #5 cotton.

4. Using the Watercolour fiber, complete **Satin Stitch** areas (shown as grey stitches on the chart).

5. Using #8 cotton, stitch all **Eight-Sided Eyelets**. (The backstitch lines show placement only.)

6. Using Ombre, make "spoke" straight stitches between the eight-sided eyelets.

7. Using 760/3727 (one strand each), stitch **Diagonal Shell motifs** in all four corners of the border.

### Remainder of the design:

8. Make **Algerian Eyelets** using #8 cotton. These stitches are located just inside the border in all four corners.

9. Complete **Three-Sided Stitch** rows (rows of attached triangles) using #12 cotton. Each leg of the three-sided stitch is done twice, and the stitch is worked from right to left. After you finish stitching the rows with the #12 cotton, re-stitch using Ombre, **stitching each leg once only!**

10. Complete **Four-Sided Stitch** rows. (rows of attached squares) using #8 cot-

ton. Then re-stitch using Ombre.

**11. Stitch the Tacked Layered Herringbone rows** (next to four -sided stitch rows) as follows:

- a. Lighter lines: 2 strands 159
- b. Heavier lines: 2 strands 160
- c. Make "tacking" stitches where indicated across entire row using Ombre.

**12.** Do the "foundation" work for the drawn thread rows (single interlace and beaded knotted cluster):

- a. Using #5 cotton, make the satin stitch bars at each end of each row.
- b. Using #12 cotton, do the hemstitching (indicated by grey areas on the chart) for each drawn thread row.

**13.** Complete **Plaited Plait Stitch** rows using Ombre for the padding, and #8 cotton for the plait stitches.

**14.** Stitch the over-one area at the center of the design, referring to the overone chart below. (The backstitch lines on the main chart are placement aids only!)

**15.** Stitch the backstitch line around the over-one area using 760/3727 (one strand each).

**16.** Finish drawn-work areas, referring to the diagrams for each row. (Please note that the diagrams show technique only: the thread counts are not accurate to this design.)

**a. Single Interlace Row:** Carefully cut the seven horizontal threads between the satin stitch bars, and withdraw those threads. Thread your needle with two strands white floss (or one strand #12 cotton) and anchor it behind the right-hand bar, bringing the needle out at the middle of the left edge of the bar, positioned to begin the row. Referring to the diagram, work across the row. The trickiest part of this stitch is getting started correctly so that the fabric threads will "twist" (interlace) properly. If you follow the diagram, you will skip one thread at the beginning of the row, and you'll also have an extra thread at the end.

Alternatively, however, you may opt to begin without skipping that first thread; the resulting "twist" will not be as pronounced, but you won't have those "extra" threads. Your choice.

**b. Beaded Knotted Clusters Row:** Carefully cut the seven horizontal threads between the vertical satin stitch bars close to those bars. Carefully withdraw the threads. Using two strands white floss threaded in a beading needle, on the back of your work, anchor the

floss in the right-hand satin stitch bar. Come out through the bar at the left edge, near the center so you are in position to start making the knotted clusters. Make the first cluster, and pull the knot tight. Then thread a bead onto the needle. Pick up the next group of threads, and make the loop for the knot, making sure the bead stays out of the loop. It's a bit tricky to keep the bead in place while pulling the knot tight. Be patient; with a little practice, you'll get it right!

Continue across the row in the same manner. Don't place a bead after making the final cluster. Secure the floss at the end of the row behind the other satin stitch bar.

**17.** Finally, attach all beads where indicated on chart.

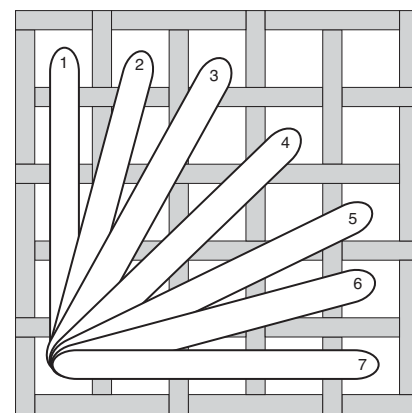

diagonal shell motif

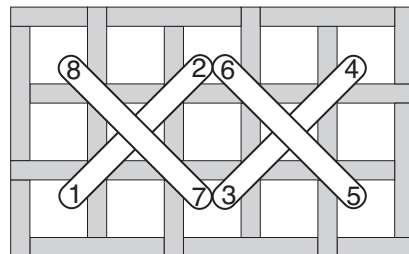

cross stitch (over-two)

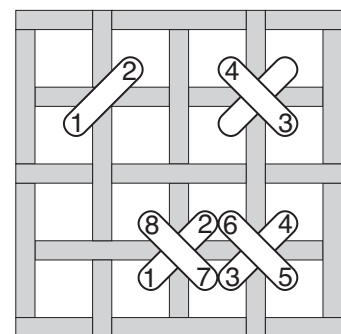

cross stitch (over-one)

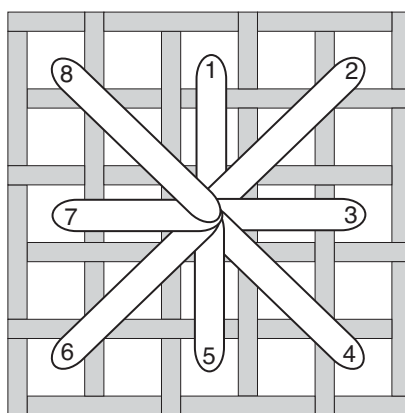

Algerian eyelet



back stitch (over-two)

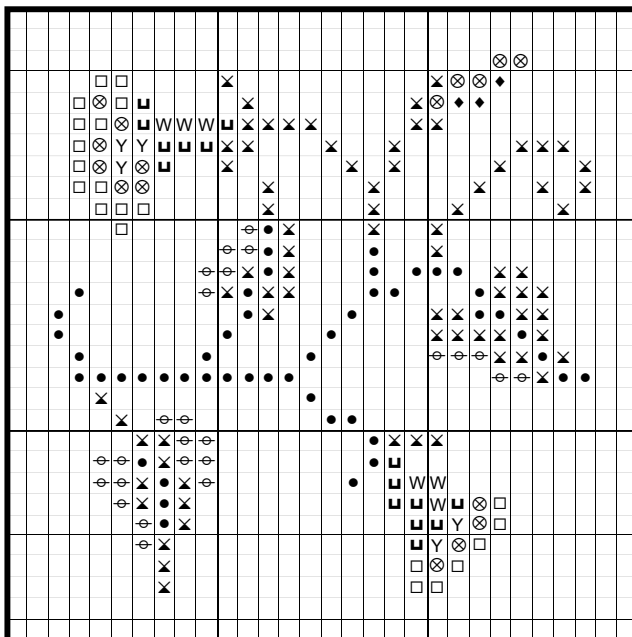

over-one chart (center of the design)

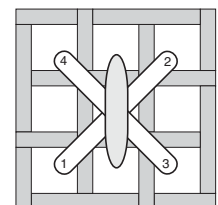

attaching a bead

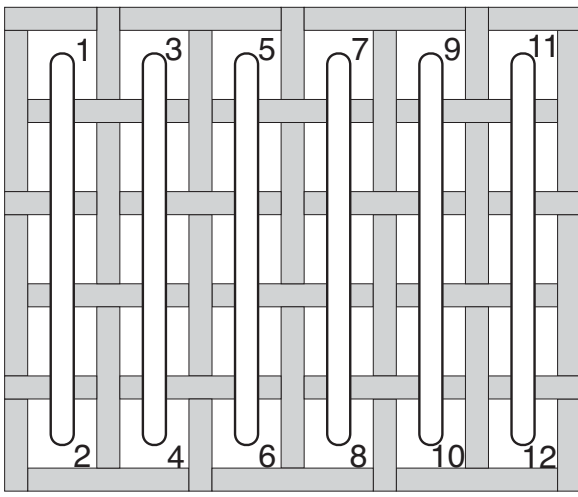

satin stitch

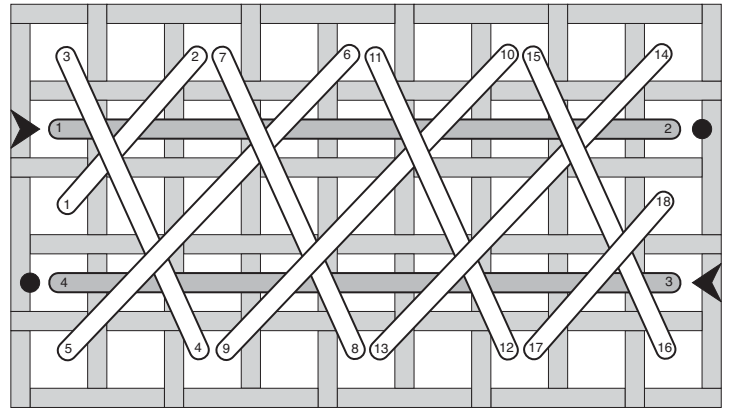

padded plait stitch

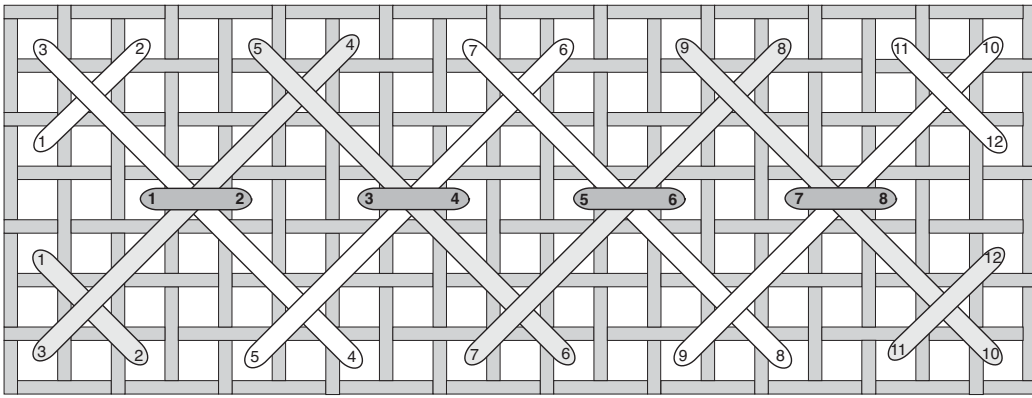

tacked layered herringbone

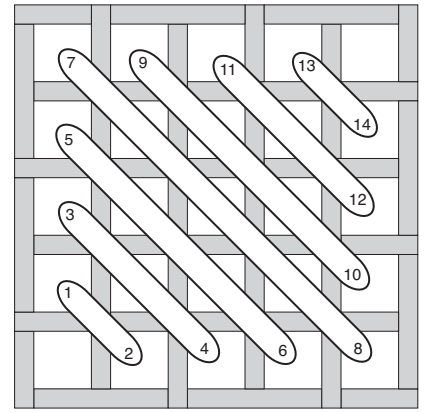

diagonal satin stitch

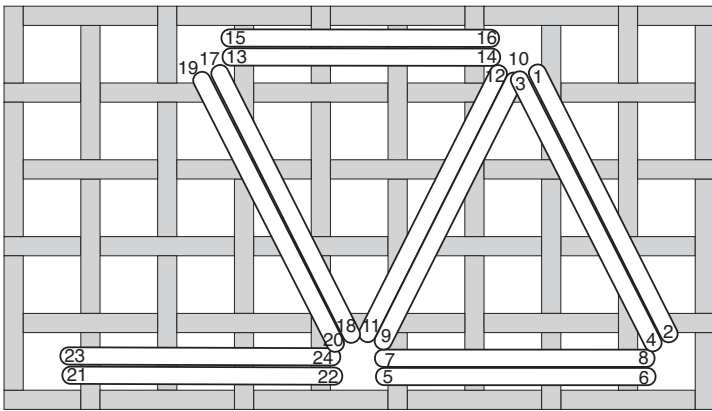

three-sided stitch

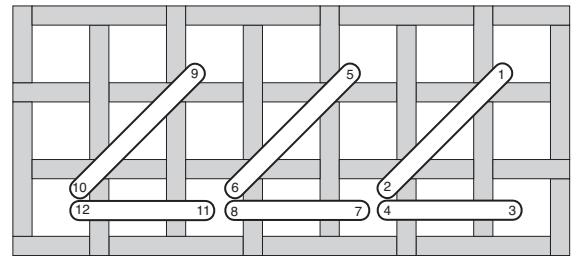

hemstitch

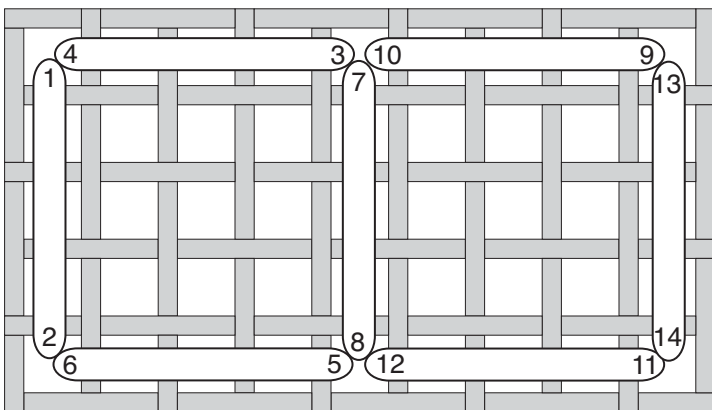

four-sided stitch

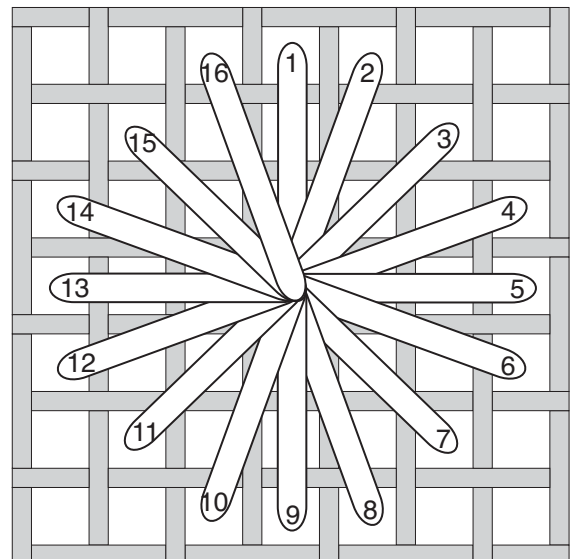

eight-sided eyelet

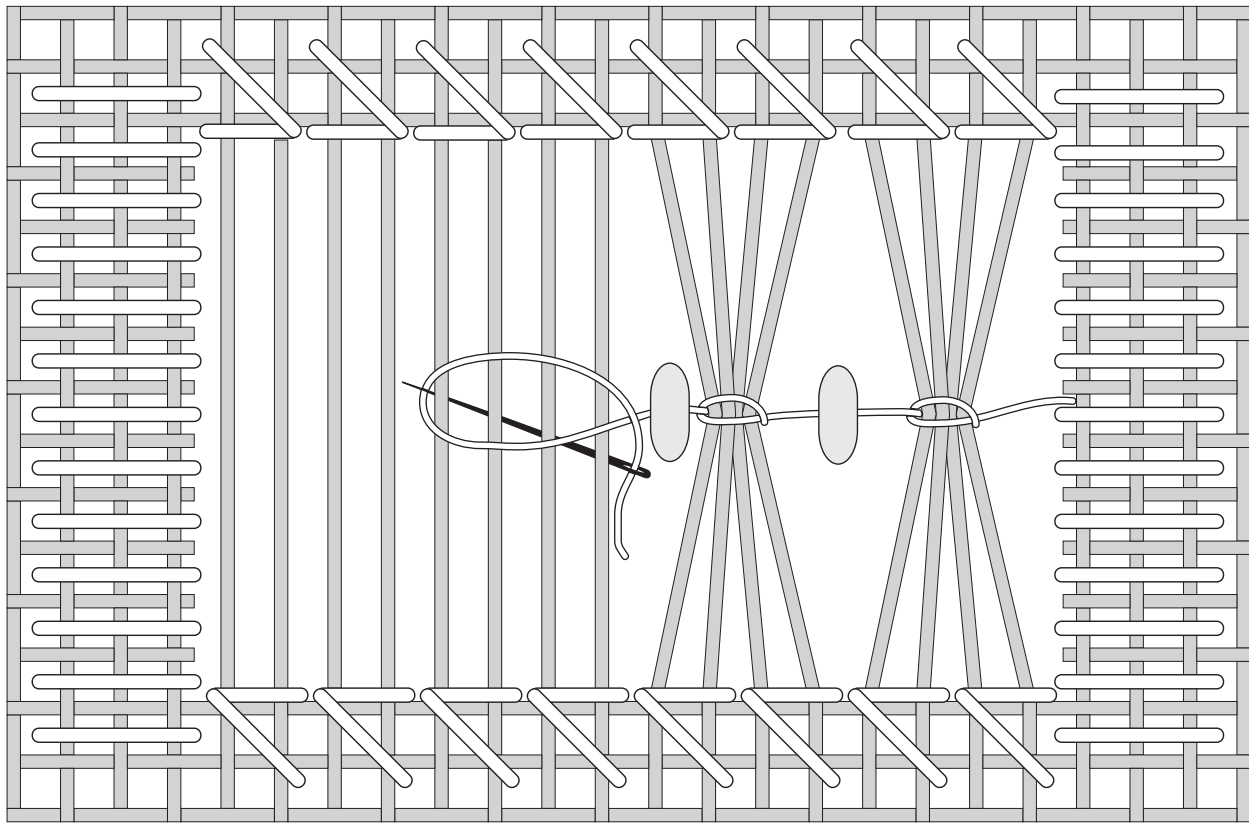

beaded knotted clusters

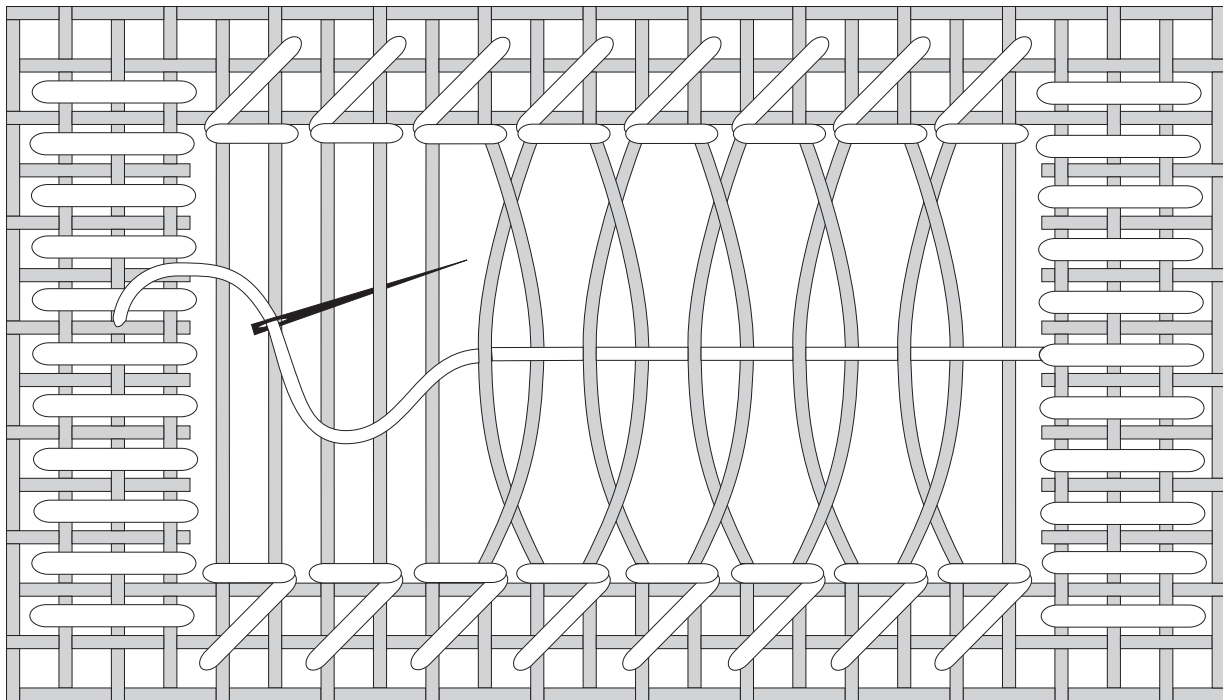

single interlace

### COPYRIGHT NOTICE

**PLEASE NOTE!!** This is a “free” chart, which means you may photocopy it. You may stitch it as many times as you’d like. Shopowners may give it to customers free of charge. However, since TW Designworks retains ownership of the copyright, **you may not sell this chart, or profit from it in any way!** (For charity/fundraising use, please contact the designer at address below.) On behalf of needlework designers, thank you for your support of copyright law.

**Teresa Wentzler, TW Designworks, PO Box 176, Montoursville, PA 17754, USA**